

TAMRON | Model: A071 Owner's manual

28-200mm F/2.8-5.6 Di III RXD

For Sony E

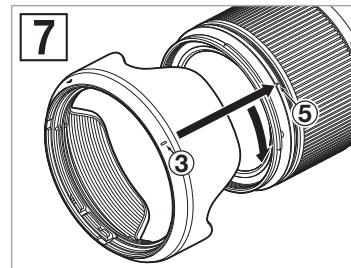
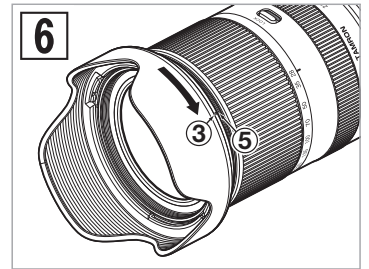
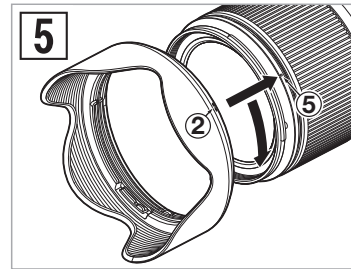
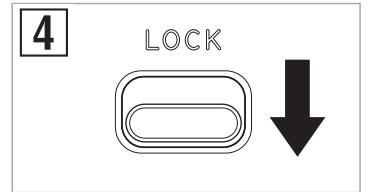
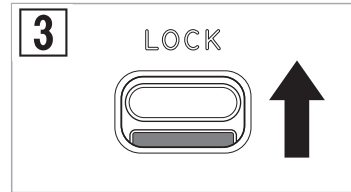
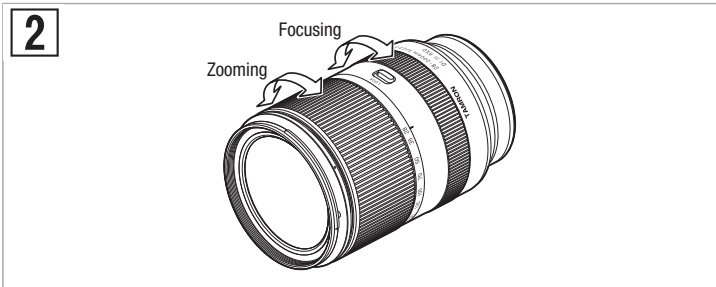
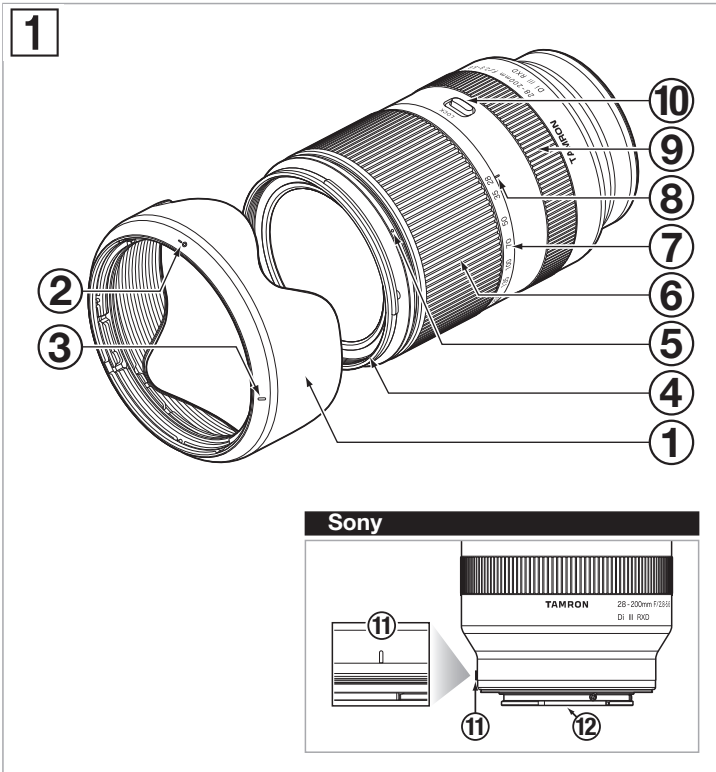

CE * The **CE** Marking is a directive conformity mark of the European Community (EC).
 * Das **CE**-Zeichen entspricht der EC Norm.
 * La marquage **CE** est un marquage de conformité à la directive CEE (CE).
 * La marca **CE** es marca de conformidad según directiva de la Comunidad Europea (CE).
 * Il marchio **CE** attesta la conformità alla direttiva della Comunità Europea (CEE).
 * **CE** 标志表示符合欧洲共同体(CE)指标

CE The EEC Conformity Report applies to the Council Directive 2014/30/EU, 2011/65/EU and is used by Tamron Co., Ltd., manufacturer of this product.

ENGLISH

Thank you for purchasing this Tamron lens. Before using your new lens, please read the contents of this Owner's manual to properly use the lens. Also, it will be important to read the manual of the camera to which you will attach the lens.

After reading, store this Owner's manual in a safe place.

Please read also the document "Precautions for Safe Use of Tamron Lenses" supplied with the lens for the detailed safety precautions to observe when using Tamron lenses.



- Explains precautions that help to prevent problems.



- Explains things you should know in addition to basic operations.

PART NAMES (Refer to Fig. 1)

- | | |
|------------------------|----------------------------------|
| ① Lens hood | ② Hood attaching alignment mark |
| ③ Hood locking mark | ④ Filter ring |
| ⑤ Hood release mark | ⑥ Zooming ring |
| ⑦ Focal length scale | ⑧ Focal length mark |
| ⑨ Focus ring | ⑩ Zoom lock switch |
| ⑪ Lens attachment mark | ⑫ Lens-camera interface contacts |

MAIN SPECIFICATIONS

Model	A071
Focal Length	28-200 mm
Maximum Aperture	F/2.8-5.6
Angle of View (diagonal)	75°23' - 12°21'
Optical Construction	14/18
Minimum Object Distance (MOD)	0.19 m (7.5") (Wide) / 0.8 m (31.5") (Tele)
Maximum Magnification Ratio	1:3.1 (Wide MOD) / 1:3.8 (Tele MOD)
Filter Size	ø 67 mm
Length	117 mm (4.6")
Maximum Diameter	ø 74 mm
Weight	575 g (20.3 oz)
Lens Hood	HA036



- Length : From tip of front element to mount surface.
- Specifications, appearance, functionality, etc. are subject to change without prior notice.

ATTACHING AND REMOVING THE LENS

Remove the rear cap of the lens. Align the lens attachment mark ⑪ and mounting mark on the camera, and then insert the lens.

Turn the lens clockwise until it locks.

To remove the lens, turn the lens in the opposite direction while pressing the lens release button on the camera.



- Turn off the power of the camera before attaching or removing the lens.



- For details, please read the instruction manual of your camera.

SWITCHING FOCUS MODE (Ref. Figs. 1, 2)

Select the desired focus mode on the camera.

For manual focusing, turn the focus ring ⑨ to acquire the desired focus.

For details, please read the instruction manual of your camera.



- In AF mode, it may be difficult for autofocus to work depending on the subject.

ZOOMING (Ref. Figs. 1, 2)

Turn the zooming ring ⑥ to adjust the focal length (Zoom position) to a desired position.

ZOOM LOCK MECHANISM (Ref. Figs. 1, 3, 4)

You can lock the zooming ring ⑥ at a focal length of 28mm to keep it from rotating.

■ Setting the zoom lock (Ref. Fig. 3)

Align 28mm on the focal length scale ⑦ with the focal length mark ⑧.

Push the zoom lock switch ⑩ toward the zooming ring.

■ Releasing the zoom lock (Ref. Fig. 4)

Push the zoom lock switch ⑩ toward the camera.



- To zoom, release the lock, and then rotate the zooming ring.

LENS HOOD (Ref. Figs. 1, 5 - 7)

A bayonet-type lens hood ① is provided as standard equipment.

We recommend shooting with the hood properly attached because the lens hood eliminates stray light that may affect the picture.

■ Using the lens hood (Ref. Figs. 5, 6)

Align the hood attaching alignment mark ② of the hood with the hood release mark ⑤ of the lens.

Rotate the hood ① in the direction of the arrow until the hood locking mark ③ meets the hood release mark ⑤.

■ Stowing the lens hood (Ref. Fig. 7)

You can stow the lens hood ① by attaching it in reverse.

Align the hood locking mark ③ of the hood with the hood release mark ⑤ of the lens.

Rotate the hood ① in the direction of the arrow until the hood attaching alignment mark ② meets the hood release mark ⑤.



- Be aware that the perimeter of the photographed image may be darkened if the hood ① is not attached properly.

PRECAUTIONS WHEN SHOOTING

- An internal focusing (IF) system is employed to reduce the minimum focus distance. Because of this, the angle of view may be wider than that of lenses using other focusing systems when shooting at a distance less than infinity.
- When using the flash, remove the lens hood and stand as far as possible from the subject. Depending on the lens and flash used, the lens may block the light from the flash and darken the bottom of the screen.
- Differences in the display systems of cameras may result in the display of values different from the maximum and minimum aperture values in the specifications. This is not an indication of an error.
- For information on the compatibility of the product with cameras, see our website. <https://www.tamron.jp/en/support/>

TO ENSURE LONG-TERM SATISFACTION

- Remove dust and soiling on the lens by using a blower or soft brush. Do not touch the lens with your fingers.
- The lens surface of the front element has been coated to prevent water and oily substances from adhering. Since it will repel water, do not use lens cleaners or other substances but only a dry cloth to clean the front element.
- To clean the lens surface of the rear element, lightly wipe it starting from the center with a commercially available lens cleaning paper, a clean cotton cloth or a microfiber cloth (cleaning cloth for glasses, etc.) moistened with lens cleaner. Do not use a silicone cloth.
- Clean the lens barrel using a silicone cloth. Never use benzene, thinner, or other organic solvents.
- Mildew is a major problem for lenses. Store your lens in a clean, cool, and dry place. When you store the lens in a lens case, store it with a commercially available drying agent and replace the drying agent occasionally.
- Do not touch the lens-camera interface contacts. If dust or stains cause contact problems, signals are not transmitted properly between the lens and camera, and malfunctions may occur.
- If the temperature changes suddenly, moisture may form within the camera and lens and cause malfunctions. To prevent this, seal your equipment in a plastic bag or similar container. After your equipment has adjusted to the ambient temperature, remove it from the bag and use it as usual.



Disposal of Electrical and Electronic Equipment in Private Households.
Disposal of used Electrical & Electronic Equipment (Applicable in the European Union and other European countries with separate collection systems)

This symbol indicates that this product shall not be treated as household waste. Instead it shall be collected separately for the recycling of electrical and electronic equipment.

If the new products are purchased, this product might be handed over to the distributor or the collection system of waste electrical and electronic equipment eventually. By ensuring this product is disposed of correctly, you will help prevent potential negative consequences for the environment and human health, which could otherwise be caused by inappropriate waste handling of this product or components of this product. If this product is disposed illegally, it might cause a possibility of penalties. For more detailed information about recycling of this product, please contact your local Civic Office, your household waste disposal service or the shop where you purchased the product.

TAMRON

ENGLISH

Precautions for Safe Use of Tamron Lenses

For safe operation be sure to carefully read the "Precautions for Safe Use of Tamron Lenses" and the manual before using the product.

After reading them, store them in a place where they can easily be reviewed whenever needed.

Caution instructions are divided into the following two categories according to the degree of danger involved.



WARNING

This indicates instructions which if not followed or if performed incorrectly could lead to death or serious injury.

- Do not view the sun or other strong light source directly through the lens or through a camera while using this lens.
Doing so could cause loss of vision, damage to the lens and/or the camera, and possibly cause the lens and/or camera to ignite.
- Do not disassemble, repair, or modify the lens.
This could damage the lens or camera.
- Keep the lens out of the reach of small children.
There is a risk of injury if the lens is dropped or falls down.



CAUTION

This indicates instructions which if not heeded or if performed incorrectly could lead to bodily injury or physical damage

- Do not place lens in direct sunlight or leave it in an extremely hot place such inside a car. Doing such could damage the internal parts of the lens or cause a fire.
- Always attach the lens cap whenever the lens is not in use.
- When attaching the lens to the camera, ensure that the lens has been properly attached to the camera and firmly locked.
If the lens is not attached properly, it could be difficult to remove or it could fall off causing damage or injury.
- Do not use this lens for any application other than photography.
- Do not transport the lens while it is still attached to a tripod.